

Steel grid resistors, system GINO (ESE)

Structure

Like the Siemens systems, the steel grid resistors of the GINO system are composed of elements made from high-alloyed steel sheet X10CrAl13 or, alternatively, chromium nickel steel NiCr 18 9 (AISI 304). The printed circuit boards of the resistor elements are punched to obtain conductors of different dimensions thus obtaining a total of 48 resistance values which allow optimal adjusting to the customer's individual requirements.

The elements are reinforced with stainless steel sheets and micanite insulation and exhibit high vibration tolerances which allow even rough operating conditions.

Up to 30 elements are mounted on support brackets and insulated by way of mica tubes.

Ceramic insulators separate the elements from each other on the one side while metallic spacer tubes establish the contact among the elements on the other side. Spring washer banks maintain the contact pressure even in case of longitudinal elongation of the support brackets due to heating up. Screw-type element connections ensure the contact even in case of high currents (elements NW8 –NW48).

Each element can be equipped with a screw-type connection which can also be moved afterwards. However, the connections are preferably applied according to a pair number of elements so that all of them are located on one side of the bank.

Both open banks with free support bracket ends and housed resistors with and without wiring are available. The elements can be combined with GINO wire-wound frame DEE (see pages 3.8) so that also higher ohm values can be realized.

Special designs for both heavy-duty conditions (maritime climate, offshore operation) and elevated operating voltages of up to 3 kV are available.

For high permanent loads, units with fan cooling are available.

Designs

Individual elements

with terminal connections for mounting by customer or for installation in resistors type key: NW (mΩ)

Open banks

Support brackets in 4 lengths, suited for taking up 3 to 30 elements.

BEP①②③④⑤⑥-resistance value

- ① No. of banks, single banks always 1
- ② = size

Size	Bracket length mm	Max. no. of elements
2	220	5
3	310	10
4	410	15
5	510	20
7	720	30

③ = protection (banks always 0 = IP00)

⑤⑥ = No. of elements

Rated voltage: 750 V AC VDE0110

Insulation class III/3

Resistance to climatic changes pursuant to DIN 50010 T1, suited for indoor and outdoor installation with varying conditions of condensation, without protection against weathering at low pollution impact. Due to the high chromium content, elements made from X10CrAl13 only corrode at the surface. The function and service life are not affected by this.

Special designs

Design M

Maritime climate, connections, bolts, nuts and connecting elements made from stainless steel.

Design O

Offshore, elements, connections and all erection components made from stainless steel.

Housed resistors BEG

in 4 sizes, different protection classes, with and without wiring, design with painted or galvanized steel sheet or corrosion-free stainless steel sheet. The housings can be stacked up to 4 high (in exceptional cases up to 6 high). Special housings according to customer requirements available.

Type key:

BEG(T)①②③④⑤-⑥⑦①

T optionally = Thermal switch

NC-contact 220 V AC – 6 A (AC1-load)
(older version: T instead of hyphen)

① number of boxes (1-6)

② size 2, 3, 4, 5, 7

③ protection class

for banks size 2, 3, 4, 5, 7

0	IP00
2	IP20
3	IP13
4	IP23

④⑤ no. of elements

⑥ Resistance value (e.g. 4R7)

⑦ design option

without appendix = standard, base coat, painted

Z = galvanized, painted – maritime climate design.

V = stainless steel, unpainted - offshore design

Tables of the permissible loads, p. 2.16

Installation

The units shall be installed horizontally such that the resistor elements are upright and the cooling air can rise freely between them.

Housings without resistors

Type key

BEL①②③ - ⑦

① = No. of boxes (1-6)

② size 2, 3, 4, 5, 7

③ protection

for banks size 2, 3, 4, 5, 7

0	IP00
2	IP20
3	IP13
4	IP23

⑦ = design Z or V (s.o.)

Admissible loads

The load values indicated in the tables are applicable for natural cooling and installation in up to 3 stacked housings.

The maximum load that can be taken on be the housing size may not be exceeded.

Care must be taken that the cooling air has unrestricted access from the bottom and can leave the unit freely at the top. The place of installation must have good venting. In particular in case of indoor installation care must be taken that the ambient air does not heat up to values above 45°C.

The indicated loads result in temperature rises of up to 260K (element temperatures in the top housing of up to 400°C). For a temperature increase of max. 200 K, the rating must be reduced by 25% (current values x 0.866).

In case of individual installation, the current values can be increased by up to 10% and for 2 stacked units by up to 5 %.

Additional forced venting by a fan, in particular in case of intermittent operation at high d.f. or in continuous operation, increases the admissible load by up to 1.4 to 1.6 times.

Connection

The bottom box is higher than those on top and the wired units are provided with a bolt-type or modular terminal block which enable connection to standard lines and cables outside of the heat zone.

Wiring is done with tin-coated solid conductors or tin-coated copper lead with silicone rubber insulation.

Threaded terminals

Rated current up to A	Terminal	Code
63	M6	BEZ001
100	M8	BEZ002
200	M10	BEZ003
400	M12	BEZ004

Modular terminals

Rated current up to A	Line up to mm ²	Code
34	4	BEZ005
44	6	BEZ006
61	10	BEZ022
82	16	BEZ007
135	35	BEZ008
207	70	BEZ009
250	95	BEZ010

Unwired units can be connected directly to the banks after taking off the side panels. In this context, the heat emanating from the units must be taken into account and the lines may have to be inserted from the side. Where necessary, heat-resistant lines or standard PVC lines/cables protected by a heat-resistant insulating sleeve shall be used.

Steel grid resistors, system GINO, elements made from AICr steel

X10CrAl13 (German mat.-no. 1.4724) is a heat-resistant special alloy that is largely corrosion resistant to all standard environmental impact. Slight surface corrosion is possible but does not affect the function and service life.

Material data:

Specific resistance: $0.9 \Omega \cdot \text{mm}^2 \cdot \text{m}^{-1}$
 Specific heat: $0.46 \text{Ws} \cdot \text{g}^{-1} \cdot \text{K}^{-1}$
 Density $7.7 \text{g} \cdot \text{cm}^3$
 Hot resistance: ca. $1.22 R_{20}$

Order description = Code

BEE (rated value)
 e.g. element with rated value 12 m Ω
 BEE12

Rated value m Ω	R ₂₀ m Ω ±10%	R ₂₇₀ m Ω ±10%	R ₄₂₀ m Ω ±10%	Cont. current A ¹⁾	Admissible load A in intermittent operation, cycle time 120 s					Current-time integral kA²s
					60 % d.f.	40 % d.f.	25 % d.f.	15 % d.f.	5 % d.f.	
8	7.7	8,8	9,4	251	290	334	402	503	841	5.30
9	8.8	10,0	10,7	234	270	311	375	468	784	3.63
10	10.1	11,5	12,3	218	251	289	348	435	728	3.39
12	11.7	13,3	14,3	199	229	263	317	396	663	2.70
14	13.5	15,4	16,5	184	212	244	294	368	615	2.47
16	15.5	17,6	18,9	172	198	228	274	343	574	1.51
18	17.7	20,1	21,6	173	199	229	276	345	577	2.99
21	20.4	23,2	24,9	145	167	193	232	290	485	1.15
24	23.5	26,7	28,7	149	172	198	238	298	498	1.97
27	27.1	30,8	33,1	138	159	183	221	275	461	1.86
31	31.1	35,4	37,9	129	149	171	206	257	430	1.31
36	35.7	40,6	43,6	120	138	158	191	238	398	1.27
41	41.2	46,9	50,3	111	128	147	176	220	368	1.15
48	47.3	53,8	57,7	104	119	137	165	205	343	0.82
55	54.3	61,8	66,2	96.1	110	127	152	190	318	0.73
63	62.7	71,3	76,5	89.0	102	117	141	176	294	0.66
72	71.9	81,8	87,7	83.0	95.2	109	132	164	274	0.48
83	82.7	94,1	101	77.0	88.2	101	122	152	254	0.41
95	95	108	116	71.4	81.2	93.8	113	140	235	0.36
110	109	124	133	64.6	74.2	85.3	103	128	214	0.47
130	126	143	154	60.2	69.1	79.5	95.7	119	200	0.40
150	145	165	177	55.5	63.8	73.3	88.2	110	184	0.33
170	166	189	203	55.2	63.3	72.8	87.6	109	183	0.33
190	191	217	233	50.3	57.7	66.3	79.7	99.5	166	0.27
220	220	250	268	46.1	52.9	60.7	73.0	91.0	152	0.22
280	252	287	307	43.8	50.3	57.7	69.4	86.5	144	0.19
290	291	331	355	40.4	46.3	53.1	63.9	79.6	133	0.16
340	335	381	409	37.8	43.3	49.6	59.6	74.3	124	0.14
390	385	438	470	34.6	39.6	45.4	54.5	67.9	113	0.11
450	442	503	539	32.0	36.6	42.0	50.4	62.8	105	0.11
510	508	578	620	30.3	34.6	39.6	47.5	59.2	98.8	0.10
590	585	665	714	27.9	31.9	36.5	43.8	54.5	90.9	0.082
670	673	766	821	25.5	29.1	33.3	39.9	49.6	82.8	0.069
770	777	884	948	23.7	27.0	30.9	37.0	46.0	76.7	0.059
890	892	1015	1088	21.8	24.8	28.4	34.0	42.2	70.4	0.048
1100	1023	1164	1248	20.3	23.1	26.4	31.6	39.2	65.3	0.041
1200	1177	1339	1436	18.8	21.4	24.4	29.2	36.2	60.3	0.035
1400	1354	1540	1652	17.4	19.7	22.5	26.9	33.3	55.5	0.029
1600	1555	1769	1897	16.2	18.3	20.9	24.9	30.9	51.4	0.024
1800	1791	2037	2185	15.0	16.9	19.2	23.0	28.5	47.3	0.020
2100	2062	2346	2516	13.8	15.6	17.7	21.1	26.1	43.4	0.017
2400	2368	2694	2889	12.7	14.3	16.2	19.3	23.9	39.7	0.014
2800	2726	3101	3326	11.7	13.2	14.9	17.8	22.0	36.4	0.011
3200	3128	3558	3816	10.9	12.2	13.8	16.4	20.2	33.5	0.010
3600	3437	3910	4193	10.2	11.0	12.2	14.1	17.2	27.9	0.0062
4000	3947	4490	4815	9.3	10.1	11.1	12.9	15.7	25.5	0.0051
4600	4544	5169	5544	8.6	9.3	10.2	11.8	14.4	23.3	0.0041
5300	5214	5931	6361	7.9	8.5	9.4	10.9	13.2	21.4	0.0035

¹⁾ The admissible load value relates to the hot resistance and 0.6 W/cm² element surface

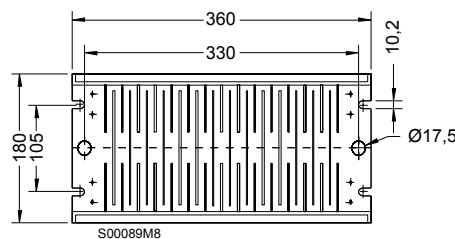

Steel grid resistors, system GINO, elements made from chromium nickel steel

X5 NiCr18 9 (Germ. material no. 1.4301) is a corrosion-free stainless steel resistant to heat up to ca. 470 °C. The hot resistance rises substantially when heated up.

Material data:

Specific resistance: $0.73 \Omega \cdot \text{mm}^2 \cdot \text{m}^{-1}$
 Specific heat: $0.5 \text{Ws} \cdot \text{g}^{-1} \cdot \text{K}^{-1}$
 Density $7.9 \text{g} \cdot \text{cm}^3$
 Hot resistance: ca. $1.37 R_{20}$

Order description = Code

BEE (rated value)V
 e.g. element with rated value 12 m Ω
 BEE12V

Rated value m Ω	R ₂₀ m Ω ±10%	R ₂₇₀ m Ω ±10%	R ₄₂₀ m Ω ±10%	Cont. current A ¹⁾	Admissible load A in intermittent operation, cycle time 120 s					Current- time integral kA ² s
					60 % d.f.	40 % d.f.	25 % d.f.	15 % d.f.	5 % d.f.	
7	6.2	7.9*	8.6	250	291	337	408	511	859	7.28
8	7.2	9.2	9.9	231	269	312	378	473	795	4.99
9	8.2	10.5	11.3	216	251	291	352	442	742	4.66
10	9.5	12.1	13.1	197	229	265	321	402	675	3.71
12	10.9	13.9	15.1	183	212	246	298	373	626	3.39
14	12.5	16.0	17.3	170	198	229	278	348	585	2.28
16	14.4	18.4	19.9	171	199	231	279	350	587	4.11
18	16.6	21.2	22.9	144	167	194	234	294	493	1.58
21	19.1	24.4	26.4	148	172	199	241	302	506	2.71
24	22.0	28.1	30.4	137	159	184	223	279	469	2.59
27	25.2	32.2	34.8	128	149	172	208	261	438	1.80
31	29.0	37.0	40.1	119	138	159	193	241	405	1.75
36	33.4	42.7	46.1	110	128	148	178	223	375	1.58
41	38.3	48.9	52.9	103	119	138	167	208	350	1.13
48	44.1	56.3	60.9	95.2	110	127	154	193	324	1.01
55	50.8	64.9	70.2	88.2	102	118	143	178	299	0.90
63	58.3	74.5	80.5	82.3	95.3	110	133	166	279	0.66
72	67.0	85.6	92.6	76.3	88.3	102	123	154	258	0.57
83	77.0	98.4	106	70.7	81.8	94.4	114	143	239	0.50
95	88.6	113	122	64.0	74.2	85.8	104	130	218	0.65
110	102	130	141	59.7	69.2	80.0	96.7	121	203	0.55
130	117	149	162	55.1	63.9	73.8	89.3	112	187	0.46
150	135	172	186	54.6	62.9	73.0	88.4	111	186	0.46
170	155	198	214	49.9	57.8	66.8	80.7	101	169	0.37
190	179	229	247	45.6	52.8	61.0	73.7	92.3	155	0.30
220	205	262	283	43.4	50.3	58.0	70.1	87.7	147	0.26
260	236	302	326	40.0	46.3	53.5	64.6	80.8	135	0.23
290	271	346	374	37.5	43.3	50.0	60.4	75.5	127	0.19
340	312	399	431	34.3	39.6	45.7	55.1	68.9	115	0.16
390	359	459	496	31.7	36.6	42.2	51.0	63.7	107	0.16
450	412	526	569	30.0	34.6	39.9	48.1	60.1	101	0.14
510	474	606	655	27.7	31.9	36.7	44.3	55.3	92.6	0.11
590	456	698	754	25.2	29.1	33.5	40.4	50.4	84.4	0.094
670	630	805	870	23.5	27.0	31.1	37.5	46.8	78.2	0.081
770	724	925	1000	21.6	24.8	28.6	34.4	42.9	71.8	0.065
890	830	1060	1147	20.1	23.1	26.6	32.0	39.9	66.7	0.056
1100	955	1220	1319	18.7	21.4	24.6	29.5	36.8	61.6	0.048
1200	1099	1404	1518	17.2	19.7	22.6	27.2	33.9	56.6	0.040
1400	1262	1612	1743	16.0	18.3	21.0	25.2	31.4	52.5	0.033
1600	1453	1856	2007	14.8	16.9	19.4	23.3	29.0	48.3	0.028
1800	1673	2137	2311	13.7	15.6	17.8	21.4	26.6	44.3	0.024
2100	1921	2454	2654	12.6	14.3	16.3	19.6	24.3	40.5	0.019

¹⁾ The admissible load relates to the heat resistance and 0.6 W/cm² element surface

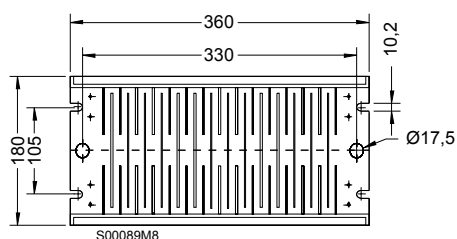

Steel grid resistors, system GINO, banks, housed resistors, dimensions

Steel grid banks for installation, protection class IP00

Description	No. of elements	Weight kg	Code
E203	3	3.4	BEP12003
E204	4	4.2	BEP12004
E205	5	5.0	BEP12005
E306	6	5.8	BEP13006
E307	7	6.6	BEP13007
E308	8	7.4	BEP13008
E309	9	8.2	BEP13009
E310	10	9.0	BEP13010
E411	11	9.8	BEP14011
E412	12	10.6	BEP14012
E413	13	11.4	BEP14013
E414	14	12.2	BEP14014
E415	15	13.0	BEP14015
E516	16	13.8	BEP15016
E517	17	14.6	BEP15017
E518	18	15.4	BEP15018
E519	19	16.2	BEP15019
E520	20	17.0	BEP15020
E721	21	17.8	BEP17021
E722	22	18.6	BEP17022
E723	23	19.4	BEP17023
E724	24	20.2	BEP17024
E725	25	21.0	BEP17025
E726	26	21.6	BEP17026
E727	27	22.6	BEP17027
E728	28	23.4	BEP17028
E729	29	24.2	BEP17029
E730	30	25.0	BEP17030

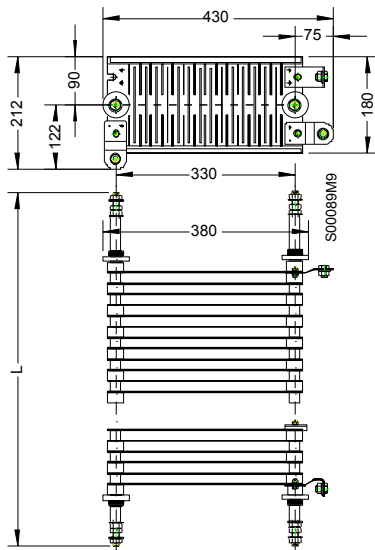

Type key: BEP1②④⑤-⑥
 BEP1 = installation bank
 protection class IP00
 ② = size

Size	Bracket length L mm	Max. no. of elements
2	220	05
3	310	10
4	410	15
5	510	20
7	720	30

④⑤ = No. of elements
 ⑥ Resistance value (e.g. 4R7)

Housings for steel grid banks

Protection class IP00, only side panels, w/o resistor bank

Description	for bank	Code	Weight ca. kg
A12	E2⑤⑥	BEL120	7
A13	E3⑤⑥	BEL130	7
A14	E4⑤⑥	BEL140	7
A15	E5⑤⑥	BEL150	7
A17	E7⑤⑥	BEL170	7
A25	E3⑤⑥	BEL250	13
A27	E5⑤⑥	BEL270	13
A37	E7⑤⑥	BEL370	19
A47	E3⑤⑥	BEL470	25
A57	E5⑤⑥	BEL570	31
A67	E7⑤⑥	BEL670	37

Protection class IP20 Side elements, front and back wall, perforated plate top, without resistor bank

Description	for bank	Code	Weight ca. kg
B12	E2⑤⑥	BEL122	11.0
B13	E3⑤⑥	BEL132	11.5
B14	E4⑤⑥	BEL142	12.3
B15	E5⑤⑥	BEL152	13.5
B17	E7⑤⑥	BEL172	15.2
B25	E3⑤⑥	BEL252	19.2
B27	E5⑤⑥	BEL272	22.8
B37	E7⑤⑥	BEL372	33.0
B47	E3⑤⑥	BEL472	43.0
B57	E5⑤⑥	BEL572	53.0
B67	E7⑤⑥	BEL672	63.0

Protection class: IP13, side elements, front and back wall, roof, without resistor bank

Description	for bank	Code	Weight ca. kg
C12	E2⑤⑥	BEL123	13.3
C13	E3⑤⑥	BEL133	14.3
C14	E4⑤⑥	BEL143	15.5
C15	E5⑤⑥	BEL153	18.0
C17	E7⑤⑥	BEL173	21.5
C25	E3⑤⑥	BEL253	26.5
C27	E5⑤⑥	BEL273	31.3
C37	E7⑤⑥	BEL373	41.5
C47	E3⑤⑥	BEL473	51.5
C57	E5⑤⑥	BEL573	61.5
C67	E7⑤⑥	BEL673	71.5

Protection class IP23, side elements, front and back wall, perforated plate top and bottom, roof, without resistor bank

Description	for bank	Code	Weight ca. kg
D12	E2⑤⑥	BEL124	13.8
D13	E3⑤⑥	BEL134	14.8
D14	E4⑤⑥	BEL144	16.0
D15	E5⑤⑥	BEL154	18.4
D17	E7⑤⑥	BEL174	22.0
D25	E3⑤⑥	BEL254	27.0
D27	E5⑤⑥	BEL274	31.8
D37	E7⑤⑥	BEL374	42.0
D47	E3⑤⑥	BEL474	52.0
D57	E5⑤⑥	BEL574	62.0
D67	E7⑤⑥	BEL674	72.0

Type key → page 2.12

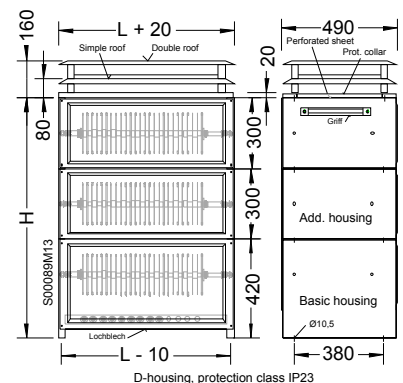
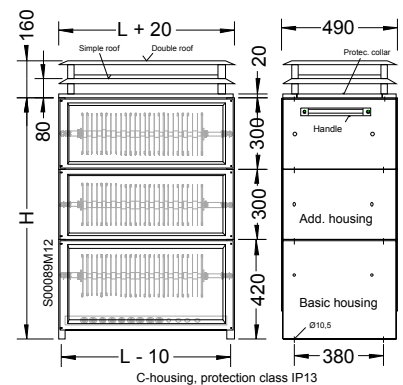
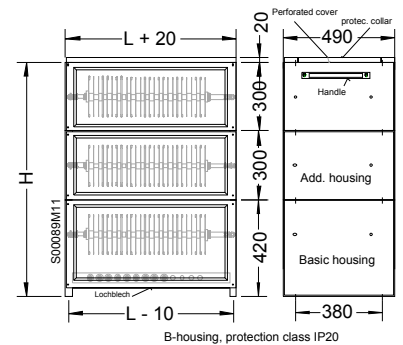
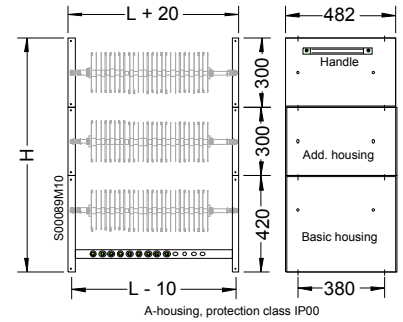

No. of boxes ②	Dimension H
1	420
2	720
3	1020
4	1320
5	1620
6	1920

Housings with 3 boxes are shown

Steel grid resistors, system GINO, housing elements

Base for individual housing, Code BEZ026

Base 112

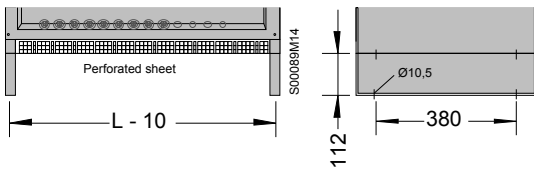

Base for multiple housings, Code BEZ027

Base 300

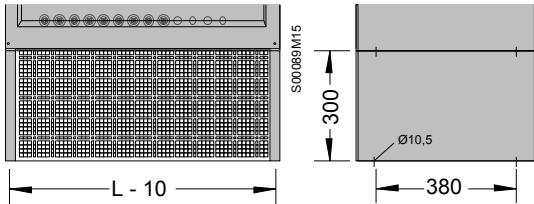

Underfloor fan

Size	Code	Description
7-1 to 65 kW	BEM081-1	Fan 400 V 3 Ph/50Hz 0.155 kW – 0.35 A 2000 m³/h at 50 Pa, 72 dB(A)
7-2 to 130 kW	BEM081-2	Fan 400 V 3 Ph/50Hz 1.0 kW – 2.1 A 4000 m³/h at 250 Pa, 90 dB(A)

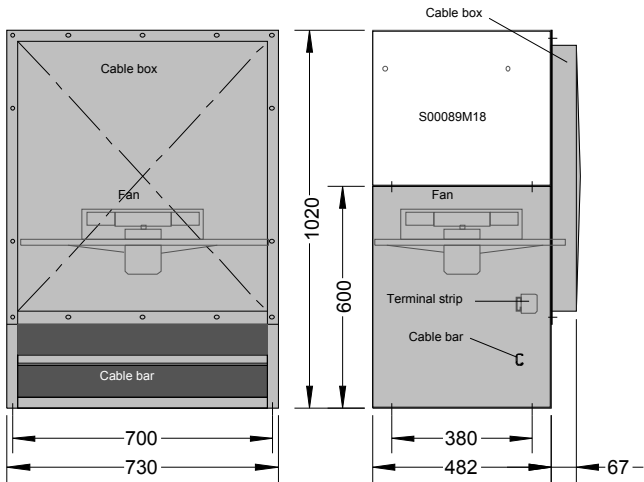

Tables of admissible loads

40°C ambient temperature,
160 K Temperature rise,
Exhaust air temperature ca. 200°C

Standard housing IP20 Installation on solid floor

Size	No. of boxes	kW
B13	1	2.7
B15	1	4.8
B25	2	6.3
B17	1	7.0
B27	2	9.1
B37	3	10.9
B47	4	12.4
B57	5	13.7
B67	6	14.9

Standard housing IP13, IP23 Installation on solid floor

Size		No. of boxes	kW
IP13	IP23		
C13	D13	1	2.7
C15	D15	1	4.7
C25	D25	2	6.1
C17	D17	1	6.8
C27	D27	2	8.9
C37	D37	3	10.6
C47	D47	4	12.1
C57	D57	5	13.4
C67	D67	6	14.5

Standard housing with base IP20 Elevated installation

Size	Base height	kW
B13	112 mm	5.7
B15	112 mm	10.3
B25	300 mm	13.5
B17	112 mm	15.2
B27	300 mm	19.9
B37	300 mm	23.7
B47	300 mm	26.9
B57	300 mm	29.8
B67	300 mm	32.5

Standard housing with simple roof and base, IP13, IP23

Size		Base height	kW
IP13	IP23		
C13	D13	112 mm	6.1
C15	D15	112 mm	9.0
C25	D25	300 mm	11.8
C17	D17	112 mm	11.7
C27	D27	300 mm	15.4
C37	D37	300 mm	18.3
C47	D47	300 mm	20.8
C57	D57	300 mm	23.1
C67	D67	300 mm	25.1

Standard housing with double roof and base, IP13, IP23

Size		Base height	KW
IP13	IP23		
C13	D13	112 mm	8.2
C15	D15	112 mm	13.1
C25	D25	300 mm	17.2
C17	D17	112 mm	17.8
C27	D27	300 mm	23.4
C37	D37	300 mm	27.8
C47	D47	300 mm	31.6
C57	D57	300 mm	35.0
C67	D67	300 mm	38.1

Steel grid resistors, system GINO, housing elements

Housing elements

Item	Description	Weight ca. kg	Code
1	Side panel, height 420 mm	3.88	BEM021
2	Side panel, height 300 mm	2.88	BEM022
3	Handle	0.26	BEM074
4	Longitudinal sheet for basic housing		
4.1	Size 3, 380 x 320 mm	1.02	BEM023
4.2	Size 5, 380 x 520 mm	1.65	BEM024
4.3	Size 7, 380 x 730 mm	2.30	BEM025
5	Longitudinal sheet for additional housing		
5.1	Size 3, 330 x 320 mm	0.86	BEM026
5.2	Size 5, 330 x 520 mm	1.37	BEM027
5.3	Size 7, 330 x 730 mm	1.92	BEM028
6	Perforated plate, top for IP20		
6.1	Size 3	0.32	BEM077
6.2	Size 5	0.52	BEM078
6.3	Size 7	0.73	BEM079
7	Longitudinal sheet, top, for IP23		
7.1	Size 3		BEM090-3
7.2	Size 5		BEM090-5
7.3	Size 7		BEM090-7
8	Roof support frame		
8.1	Size 3, 320 mm	1.43	BEM032
8.2	Size 5, 520 mm	1.94	BEM033
8.3	Size 7, 720 mm	2.47	BEM034
9	Roof		
9.1	Size 3, 320 mm	1.38	BEM038
9.2	Size 5, 520 mm	2.18	BEM039
9.3	Size 7, 720 mm	3.08	BEM040
10	Double roof		
10.1	Size 3, 320 mm		BEM080-3
10.2	Size 5, 520 mm	3.36	BEM080-5
10.3	Size 7, 720 mm	4.40	BEM080-7
11	Terminal strip board 270 mm, for size 3		
11.1	For 8 bolt-type terminals 63 A	0.28	BEM041
11.2	For 7 bolt-type terminals 100 A	0.27	BEM042
11.3	For 6 bolt-type terminals 200 A	0.26	BEM043
11.4	For 4 bolt-type terminals 400 A	0.26	BEM044
	Terminal strip board 470 mm, for size 5		
11.5	For 14 bolt-type terminals 63 A	0.47	BEM045
11.6	For 12 bolt-type terminals 100 A	0.47	BEM046
11.7	For 10 bolt-type terminals 200 A	0.43	BEM047
11.8	For 8 bolt-type terminals 400 A	0.43	BEM048
	Terminal strip board 680 mm, for size 7		
11.9	For 21 bolt-type terminals 63 A	0.66	BEM049
11.10	For 18 bolt-type terminals 100 A	0.66	BEM050
11.11	For 16 bolt-type terminals 200 A	0.62	BEM051
11.12	For 12 bolt-type terminals 400 A	0.61	BEM052
12	Bolt-type terminals DIN 46260 form D		
12.1	M6 63 A steel, galvanized	0.06	BEM053-0
12.2	M6 63 A stainless steel	0.06	BEM053
12.3	M8 100 A steel galvanized	0.10	BEM054-0
12.4	M8 100 A stainless steel	0.10	BEM054
12.5	M10 200 A steel, galvanized	0.16	BEM055-0
12.6	M10 200 A stainless steel	0.16	BEM055
12.7	M12 400 A steel, galvanized	0.28	BEM056-0
12.8	M12 400 A stainless steel	0.28	BEM056
13	Perforated plate, bottom for IP20/IP23		
13.1	For size 3	0.42	BEM077U
13.2	For size 5	0.68	BEM078U
13.3	For size 7	0.95	BEM079U
14	Base, height 112 mm		
14.1	For size 3		BEM088-3
14.2	For size 5		BEM088-5
14.3	For size 7		BEM088-7
15	Base height 300 mm, with perforated plate		
15.1	For size 3		BEM089-3
15.2	For size 5		BEM089-5
15.3	For size 7		BEM089-7
16	Bracket to reinforce the housing fixture for size 7		
17	Cable box for size 7		
18	Name plate		
18.1	Neutral	-	BEM073N
18.2	GINO	-	BEM073G

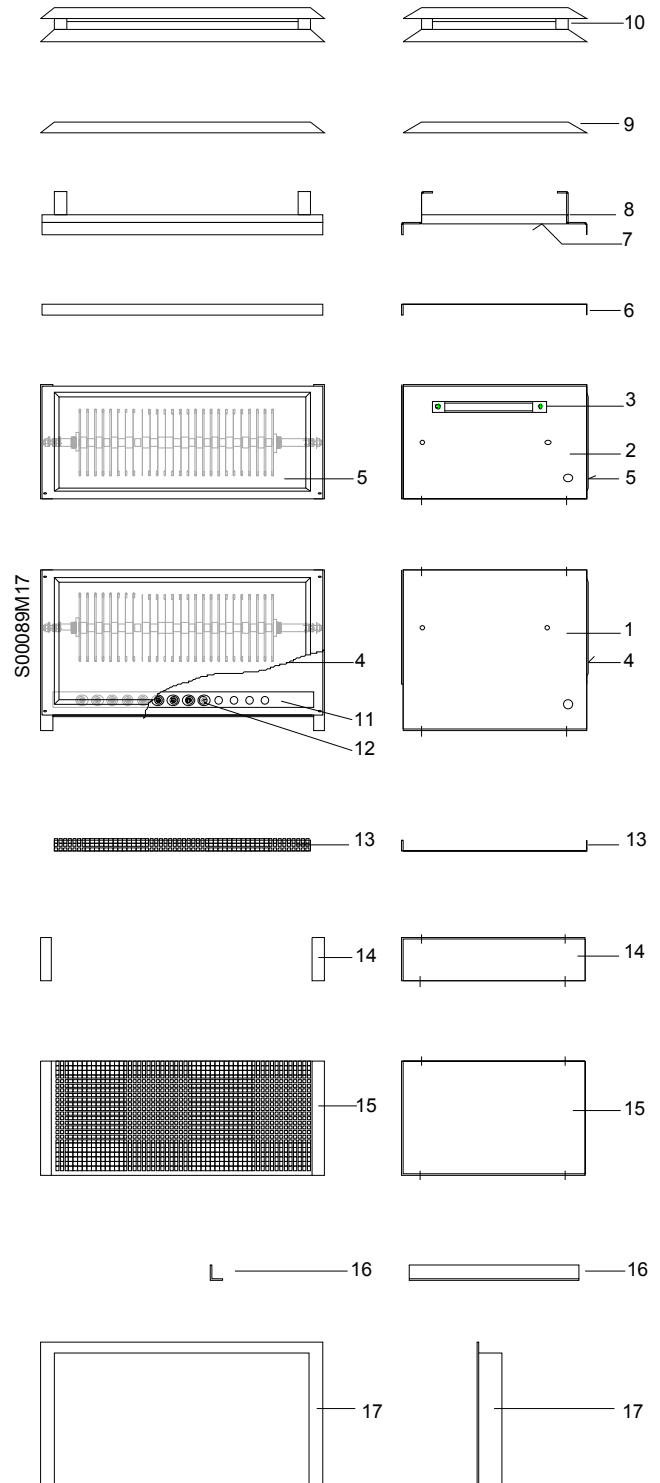

Steel grid resistors, system GINO, spare and mounting components

Item	Description	Weight ca. kg	Code
1	Resistor element NW ..	0.5	BEE**
2	Support bracket for bank, with M12		
2.1	For E2**, length 220 mm	0.18	BEM001
2.2	For E3**, length 310 mm	0.23	BEM002
2.3	For E5**, length 510 mm	0.38	BEM003
2.4	For E7**, length 720 mm	0.53	BEM004
3	Insulating tube,		
3.1	For E2**, length 150 mm	0.015	BEM005
3.2	For E3**, length 240 mm	0.024	BEM006
3.3	For E5**, length 440 mm	0.044	BEM007
3.4	For E7**, length 650 mm	0.065	BEM008
4	Spacer tube Ø 18 x 22 x length 18 mm	0.018	BEM009
5	Spacer ring, ceramic material		
5.1	Unglazed	0.035	BEM010
6	Ring-type insulator, end insulation or phase separation	0.05	BEM011
7	Spring washer		
7.1	A18 steel	0.012	BEM012
7.2	A10 V2A	0.012	BEM012V
8	Washer DIN 126-17.5	-	NSS126-0021
9	Washer 12.9 x 34.5 x 2 mm thick	-	BEM...
10	Spacer tube Ø for support bracket		
10.1	Ø 18 x 22 x length 10 mm	0.010	BEM013
10.2	Ø 18 x 22 x length 40 mm	0.040	BEM014
11	Hexagonal nut DIN 934-M12	-	NMS934-0071
12	Serrated lock washer DIN6798-A13	-	NSF6798-0041
13	Spacer tube for screw-type connection		
13.1	Ø 11 x 18 x length 13 mm	0.022	BEM013
13.2	Ø 11 x 18 x length 40 mm	0.023	BEM014
14	Hexagonal nut for element screw connection		
14.1	63 A, DIN 933-M6x30	-	NSS933-
14.2	100 A, DIN 933-M8x30	-	NSS933
14.3	200 A, DIN 933-M10x30	-	NSS933
15	Hexagonal nut for element screw connection		
15.1	63 A, DIN 439-M6	-	NMS439-
15.2	100 A, DIN 439-M8	-	NMS439
15.3	200 A, DIN 439-M10	-	NMS439
16	Spring washer for element screw connection		
16.1	63 A, DIN 127-B6	-	NRF127-
16.2	100 A, DIN 127-B8	-	NRF127-
16.3	200 A, DIN 127-B10	-	NRF127-
17	Connecting pieces		
17.1.1	63 A, steel, galvanized	0.081	BEM17
17.1.2	63 A, stainless steel	0.081	BEM17V
17.1.3	100 A, steel, galvanized	0.093	BEM18
17.1.4	100 A, stainless steel	0.093	BEM18V
17.1.5	200 A, steel, galvanized	0.115	BEM19
17.1.6	200 A, stainless steel	0.115	BEM19V
17.2.1	400 A, steel, galvanized	0.135	BEM20
17.2.2	400 A, stainless steel	0.135	BEM20V
18	Hexagonal nut DIN 933-M10 x 12	0.018	NSS933-0061
19	Spring-type washer		
19.1	For 63 A, DIN 127-B6	0.003	NRF933-
19.2	For 100 A, DIN 127-B8	0.003	NRF933-
19.3	For 200 A, DIN 127-B10	0.003	NRF933-
20	Plain washer		
20.1	For 63 A, DIN 125-A6	-	NSS125-
20.2	For 100 A, DIN 125-A8	-	NSS125-
20.3	For 200 A, DIN 125-A10	-	NSS125-
21	Hexagonal nut		
21.1	63 A, DIN 934-M6	-	NMS934-
21.2	100 A, DIN 934-M8	-	NMS934-
21.3	200 A, DIN 934-M10	-	NMS934-
22	Hexagonal nut DIN 934-M12x30	0.038	NSS933-0155
23	Spring-type washer DIN 127-B12	-	NRF127-
w/o fig.	Element connection 400 A		
	With connection items 13 to16 + 17.2.1, galvanized	0.21	BEM015
	dto. items 13 to16 + 17.2.1, V2A.	0.21	BEM015V
	w/o connection items 13 to16, galv.	0.21	BEM016
	dto. items 13 to16, V2A	0.21	BEM016V
w/o fig.	GINO name plate		BEM073G
	Name plate neutral		BEM073N
24	Bolt-type terminals DIN 46260 Form D		
24.1	M6 galvanized steel, 63 A		BEM053-0
24.2	M8 galvanized steel, 100 A		BEM054-0
24.3	M10 galvanized steel, 200 A		BEM055-0
24.4	M12 galvanized steel, 400 A		BEM056-0
24.5	M6 stainless steel, 63 A		BEM053
24.6	M8 stainless steel, 100 A		BEM054
24.7	M10 stainless steel, 200 A		BEM055
24.8	M12 stainless steel, 400 A		BEM056

